

ULTRA V/L

CARATTERISTICHE COSTRUTTIVE / CONSTRUCTION FEATURES CARACTERÍSTICAS CONSTRUCTIVAS / CARACTÉRISTIQUES D'EXÉCUTION

Corpo pompa Pump body	ghisa cast iron
Cuerpo bomba Corps de pompe	fundición fonte
Supporto motore Motor bracket Soporte motor Support moteur	ghisa cast iron fundición fonte
Girante, diffusore Impeller, diffuser Rodete, difusore Turbine, diffuseur	Noryl®
Camicia, albero motore Shaft, motor shaft Camisa, eje motor Chemise, arbre moteur	acciaio cromo-nickel AISI 304 stainless steel AISI 304 acero cromo-níquel AISI 304 acier chrome-nickel AISI 304
Tenuta meccanica Mechanical seal Sello mecánico Garniture mécanique	ceramica-grafite ≤ 6 giranti grafite-carburo di silicio ≥ 7 giranti ceramic-graphite ≤ 6 impellers graphite-silicon carbide ≥ 7 impellers cerámica-grafito ≤ 6 rodetes grafito-carburo de silicio ≥ 7 rodetes céramique-graphite ≤ 6 turbines graphite-carbure de silicium ≥ 7 turbines
Cuscinetto intermedio guida albero Intermediate shaft guiding stage bush Cojinete intermedio guía-eje Douilles étage de guidage intermédiaire	ceramica-carburo di tungsteno ceramic-tungsten carbide ceramica-carburo de tungsteno céramique-carbure de tungstène
Temperatura ambiente Ambient temperature Temperatura del ambiente Température ambiante	max 40 °C
Temperatura del liquido Liquid temperature Temperatura del líquido Température du liquide	+5 ÷ +35 °C
Pressione max di esercizio Max operating pressure Presión max de trabajo Pression max de fonctionnement	8 bar ≤ 6 giranti; 14 bar ≥ 7 giranti 8 bar ≤ 6 impellers; 14 bar ≥ 7 impellers 8 bar ≤ 6 rodetes; 14 bar ≥ 7 rodetes 8 bar ≤ 6 turbines; 14 bar ≥ 7 turbines
Guarnizione corpo pompa Pump body gasket Guarniciones cuerpo bomba Joint corps de pompe	EPDM

MOTORE / MOTOR / MOTOR / MOTEUR

Motore 2 poli a induzione 2 pole induction motor Motor de 2 polos a inducción Moteur à induction à 2 pôles	3~ 230/400V-50Hz 1~ 230V-50Hz con termoprotettore fino a 1,85kW with thermal protection up to 1,85 kW con protección térmica hasta 1,85 kW avec protection thermique jusqu'à 1,85 kW
Classe di isolamento Insulation class Clase de aislamiento Classe d'isolation	F
Grado di protezione Protection degree Grado de protección Protection	IP44 IP55 ≥ 4,5 HP

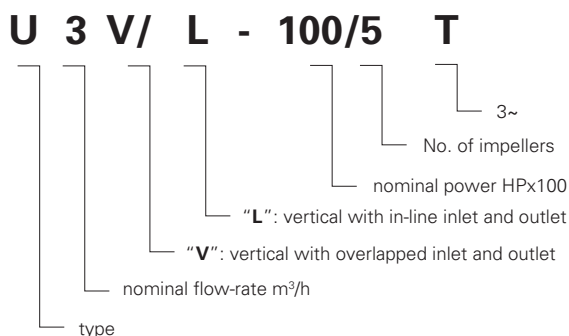

ULTRA V



ULTRA 3-5-7 L



ULTRA 9-18 L



Pompe centrifughe multistadio verticali. Adatte alla movimentazione di liquidi non carichi; sistemi di pressurizzazione; irrigazione; acque potabili o con glicole in soluzione; trattamento acque; industria alimentare; riscaldamento e condizionamento; sistemi di lavaggio.

Stainless steel multistage vertical pumps. Pumping of clean non-loaded fluids; pressurizing system; irrigation; drinking and glycol water; water treatment; food industry; heating and air conditioning; washing system.

Bombas centrífugas multietapas verticales. Bombeo de líquidos químicamente y mecánicamente no agresivos; sistemas de presurización; riego; agua potable o con glicol; tratamientos del agua; industria alimentaria; calefacción y refrigeración; sistemas de lavado.

Pompes centrifuges multicellulaires verticales. Pompage d'eaux propres non chargées; groupes de surpression; irrigation; eau potable ou solution de glycol; traitement des eaux; industrie alimentaire; chauffage et climatisation; stations de lavage auto.

ULTRA V/L

3 V/L

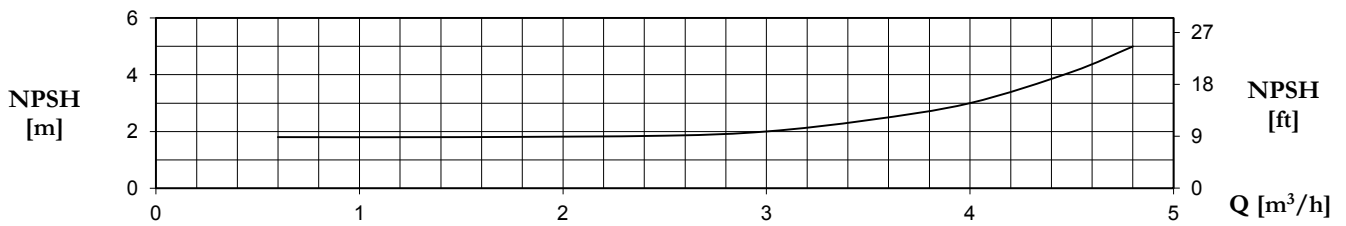
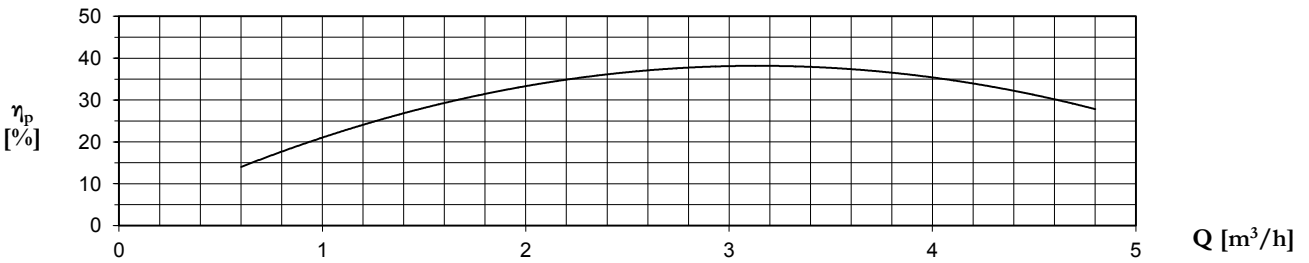
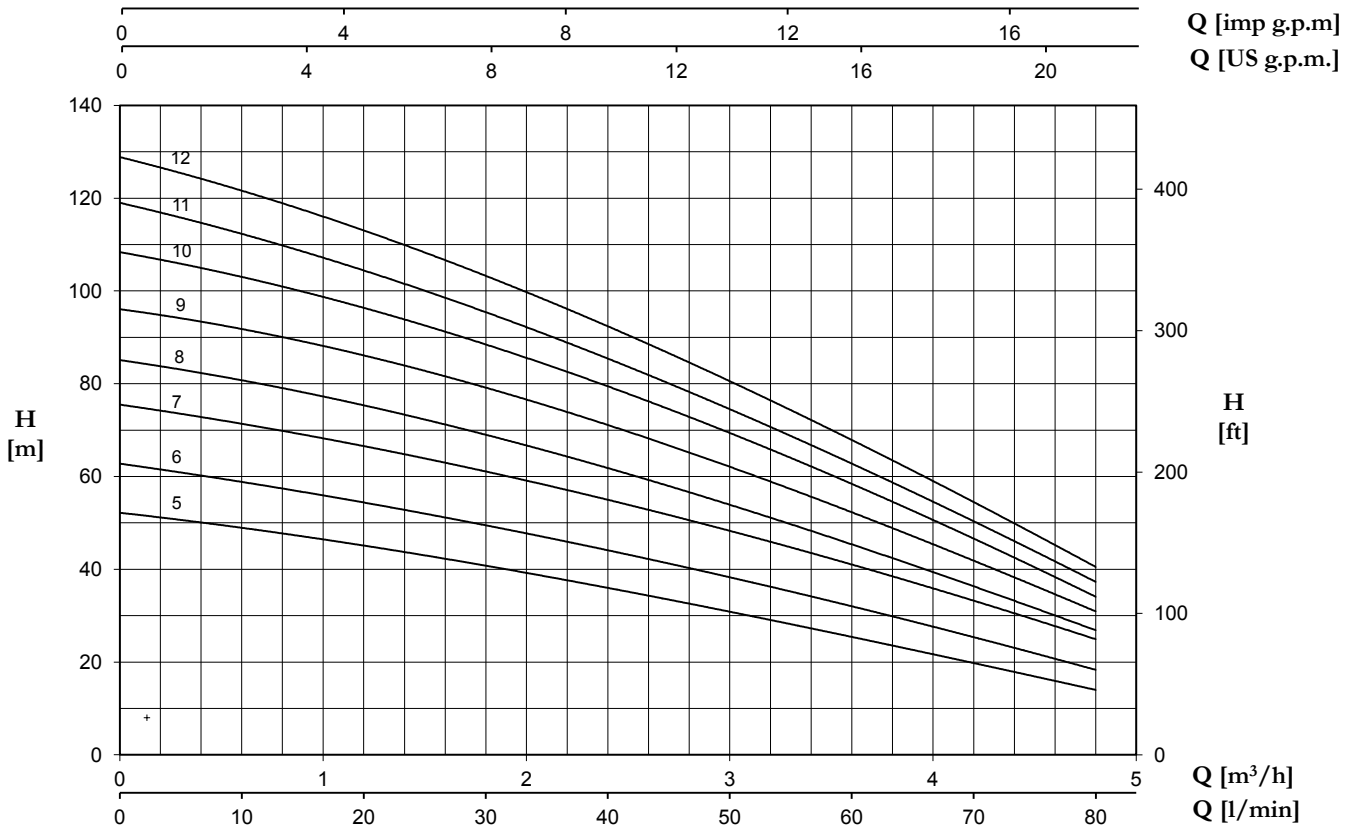

U 3... V/L		P2		P1 (kW)		AMPERE		Q (m³/h - l/min)						
1~	3~					1~	3~	0	0,6	1,2	1,8	2,4	3,6	4,8
		0	10	20	30			40	60	80				
		(HP)	(kW)	1~	3~	1x230 V	3x400 V	H (m)						
						50 Hz	50 Hz							
U 3...-100/5	U 3...-100/5 T	1	0,75	1,1	1	4,8	1,9	52,2	48,9	45,1	40,8	36,0	25,4	14,0
U 3...-120/6	U 3...-120/6 T	1,2	0,9	1,2	1,2	5,6	2,6	62,8	58,7	54,5	49,6	43,9	32,1	18,3
U 3...-150/7	U 3...-150/7 T	1,5	1,1	1,5	1,5	7,1	2,9	75,5	71,3	66,6	61,2	54,8	41,1	24,9
U 3...-180/8	U 3...-180/8 T	1,8	1,3	1,7	1,6	7,5	3	85,2	80,6	75,1	69,3	61,9	45,2	26,9
U 3...-200/9	U 3...-200/9 T	2	1,5	1,9	1,8	8,4	3,3	95,8	92,2	86,3	78,9	70,7	52,7	30,8
U 3...-250/10	U 3...-250/10 T	2,5	1,8	2,1	2	10	4,1	108,4	102,9	96,5	88,2	79,7	58,3	34,1
U 3...-280/11	U 3...-280/11 T	2,8	2,1	2,3	2,2	10,5	4,3	119,0	112,3	104,4	95,3	85,6	62,7	37,3
U 3...-300/12	U 3...-300/12 T	3	2,2	2,5	2,4	11,2	4,7	128,9	121,5	113	103,5	92,2	67,9	40,5

5 V/L

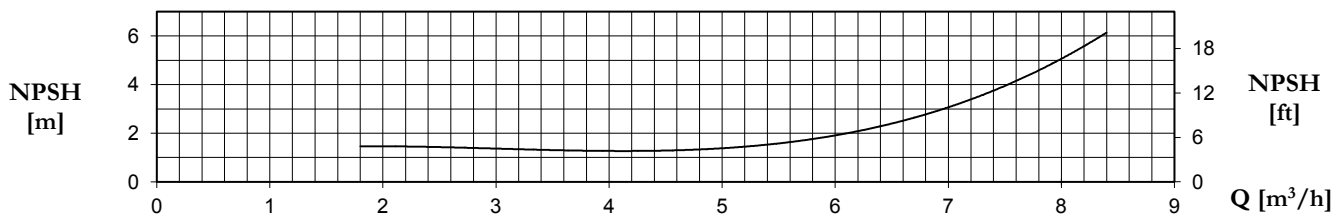
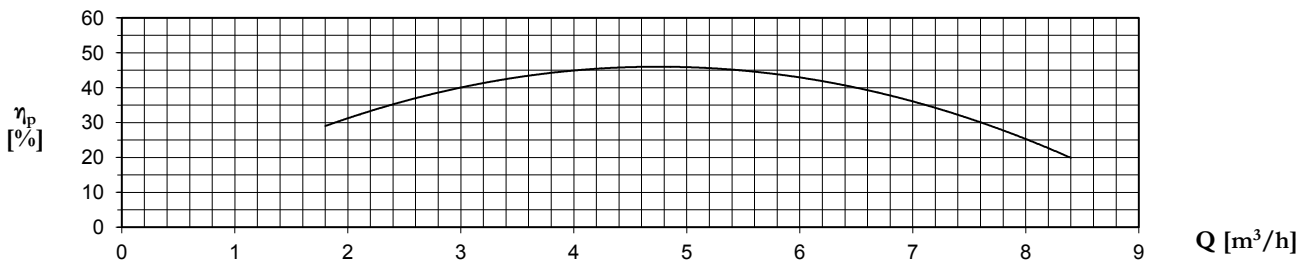
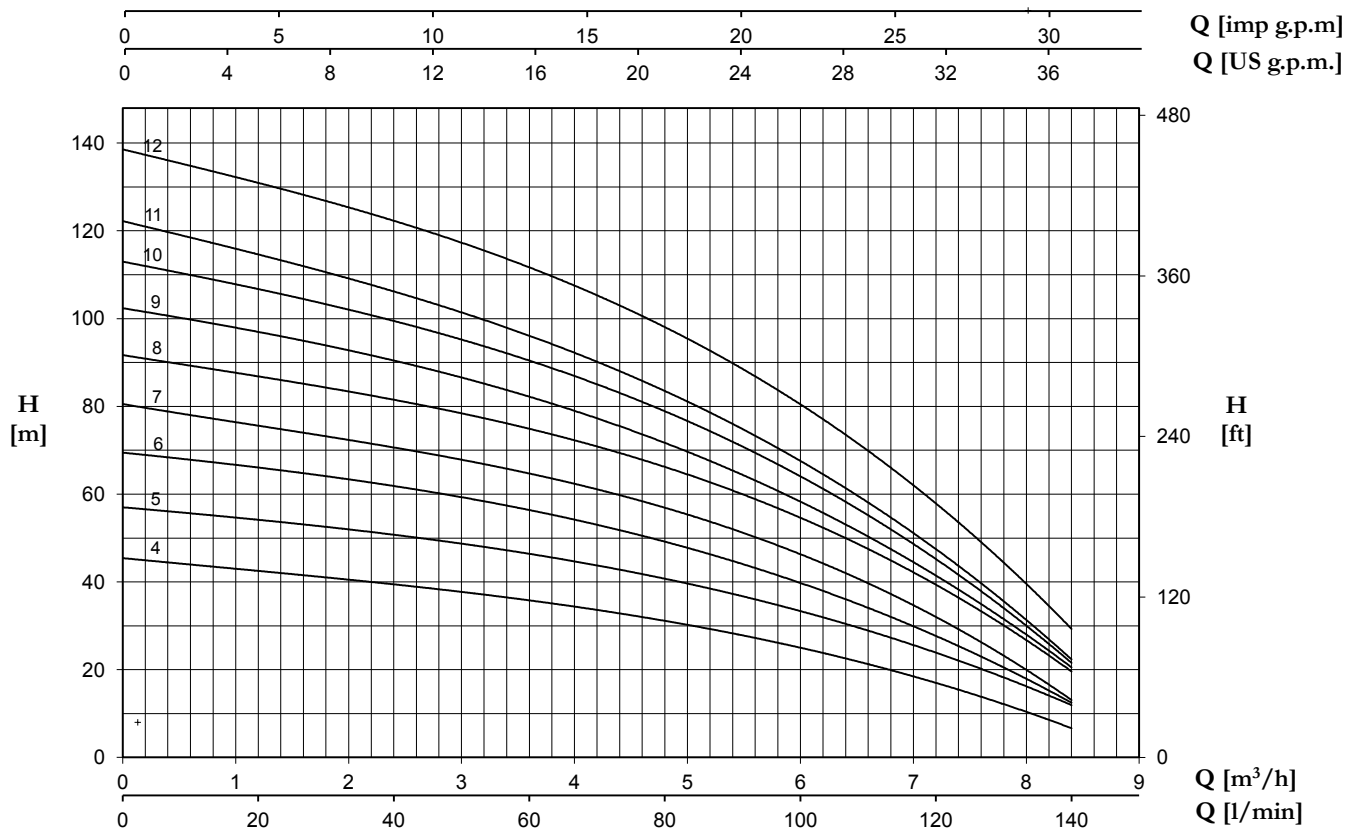

U 5... V/L		P2		P1 (kW)		AMPERE		Q (m³/h - l/min)							
1~	3~					1~	3~	0	1,8	2,4	3,6	4,8	6	7,2	8,4
						50 Hz	50 Hz	0	30	40	60	80	100	120	140
		(HP)	(kW)	1~	3~	1x230 V 50 Hz / 3x400 V 50 Hz		H (m)							
U 5...-120/4	U 5...-120/4 T	1,2	0,9	1,13	1,13	5,2	2,5	45,3	41,3	39,6	35,6	30,8	24,9	17,6	6,4
U 5...-150/5	U 5...-150/5 T	1,5	1,1	1,47	1,39	6,8	2,8	56,8	53	51	46,1	40,1	33,3	24,8	11,5
U 5...-180/6	U 5...-180/6 T	1,8	1,3	1,7	1,62	7,7	3	69,3	64,4	62,0	55,6	48,2	39,6	28,8	12,0
U 5...-200/7	U 5...-200/7 T	2	1,5	2	1,86	9	3,4	80,3	73,6	71,0	64,5	56,1	46,0	33,4	12,5
U 5...-250/8	U 5...-250/8 T	2,5	1,87	2,37	2,17	10,7	4,1	91,4	85,0	81,8	74,3	65,5	54,7	40,4	19,1
U 5...-280/9	U 5...-280/9 T	2,8	2,1	2,6	2,4	11,7	4,4	102,1	94,6	90,7	81,6	71,0	58,5	42,3	20,1
U 5...-300/10	U 5...-300/10 T	3	2,2	2,84	2,73	12,8	4,9	112,7	103,9	99,9	89,8	78,2	64	46,4	21
U 5...-350/11	U 5...-350/11 T	3,5	2,6	2,95	2,89	13,3	5	122,0	111,2	106,3	95,6	83,1	67,6	48,2	22,0
-	U 5...-380/12 T	3,8	2,85	-	3,2	-	6,0	138,4	127,2	122,4	111,7	97,3	80,4	58,8	28,9

ULTRA V/L

7 V/L

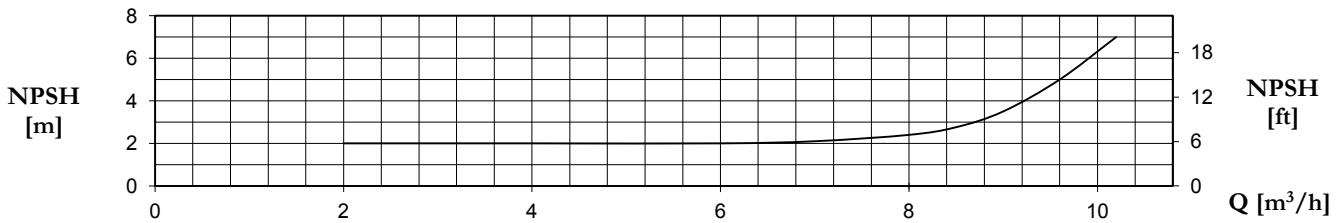
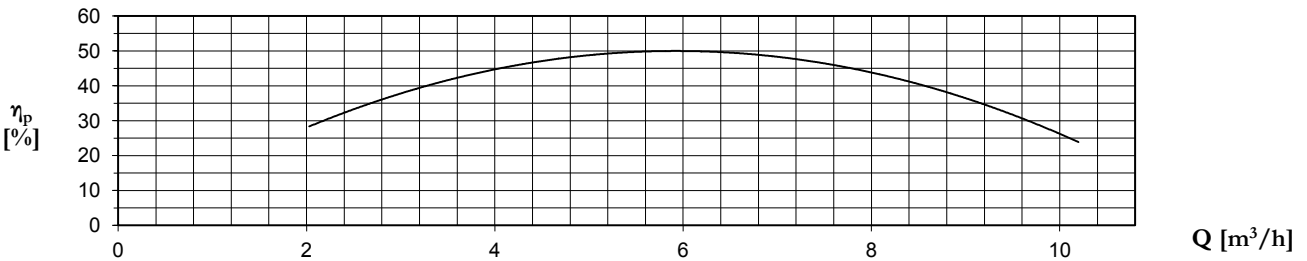
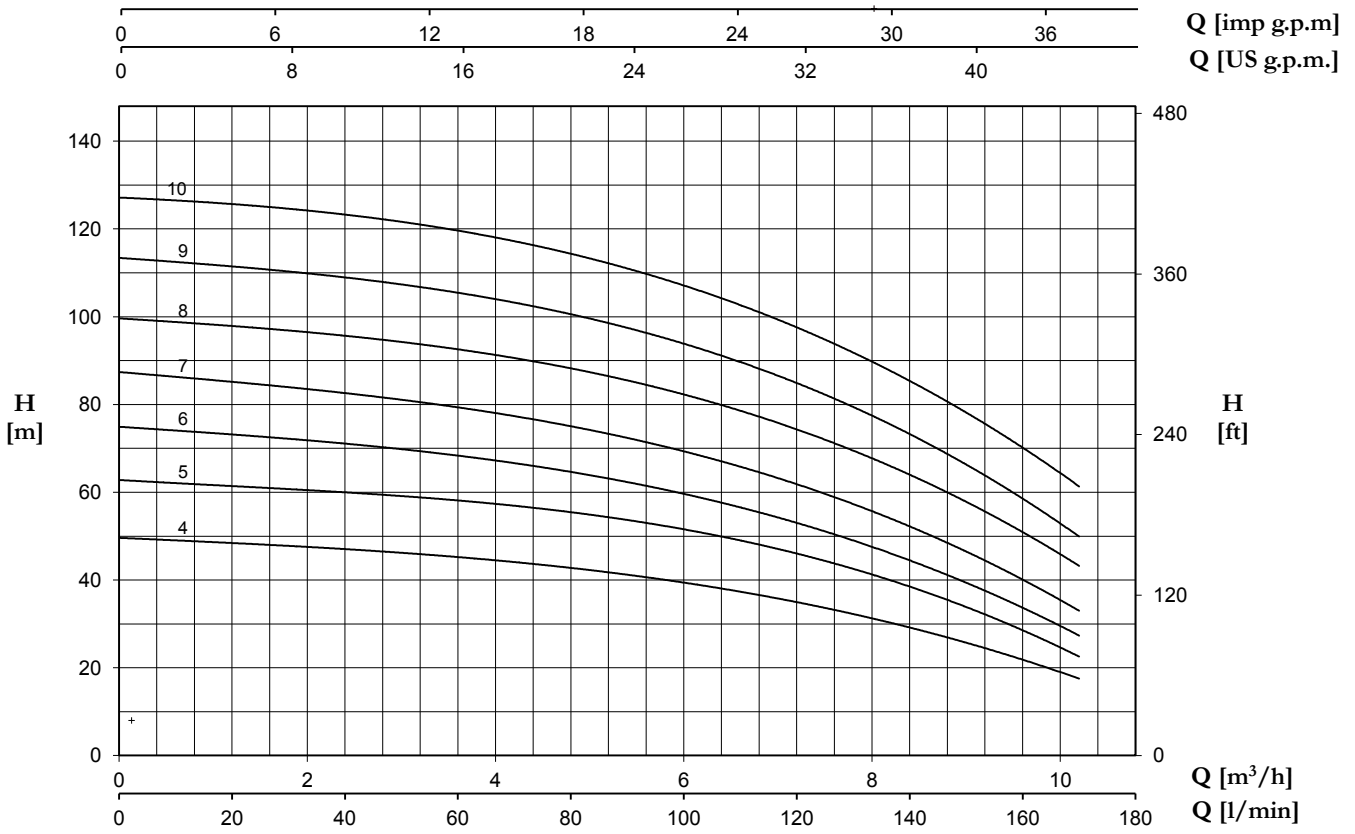

U 7... V/L		P2		P1 (kW)		AMPERE		Q (m³/h - l/min)									
1~	3~	(HP)	(kW)	1~	3~	1~	3~	0	2,4	3,6	4,8	6	7,2	8,4	9,6	10,2	
						50 Hz	50 Hz	0	40	60	80	100	120	140	160	170	
								H (m)									
U 7...-180/4	U 7...-180/4 T	1,8	1,3	1,83	1,71	8,3	3,2	49,5	47,4	45,3	42,5	39,2	34,8	29,4	22,6	16,9	
U 7...-250/5	U 7...-250/5 T	2,5	1,85	2,39	2,15	10,9	4,2	62,6	60,6	58,2	55,1	51,1	45,8	38,9	29,8	21,5	
U 7...-300/6	U 7...-300/6 T	3	2,2	2,68	2,63	12,2	5	74,8	71,5	68,3	64,5	59,3	53,0	44,6	34,5	26,7	
-	U 7...-350/7 T	3,5	2,6	-	3,04	-	5,5	87,2	83,3	79,3	74,6	68,9	61,9	52,5	41,0	32,2	
-	U 7...-400/8 T	4	3	-	3,6	-	6,8	99,5	96,1	92,6	87,9	81,9	74,5	64,4	51,0	43,0	
-	U 7...-450/9 T	4,5	3,31	-	4,09	-	7,0	113,2	109,7	105,4	100,1	93,5	84,8	73,6	59,6	49,0	
-	U 7...-550/10 T	5,5	4	-	4,6	-	8,3	127,0	123,8	119,6	114,1	106,6	97,6	86,0	70,3	61,0	

9 V/L

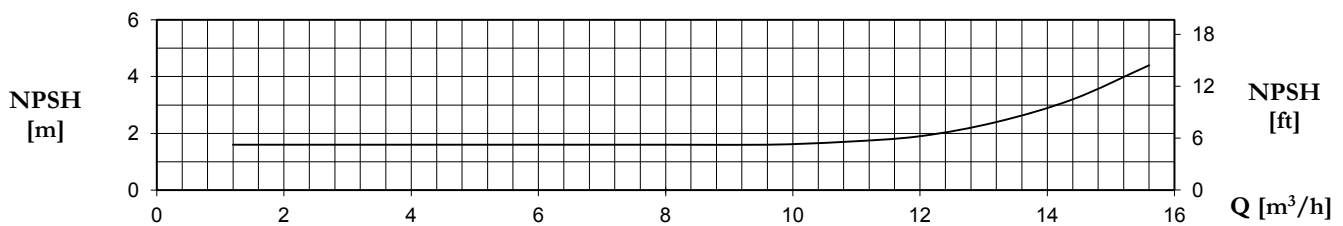
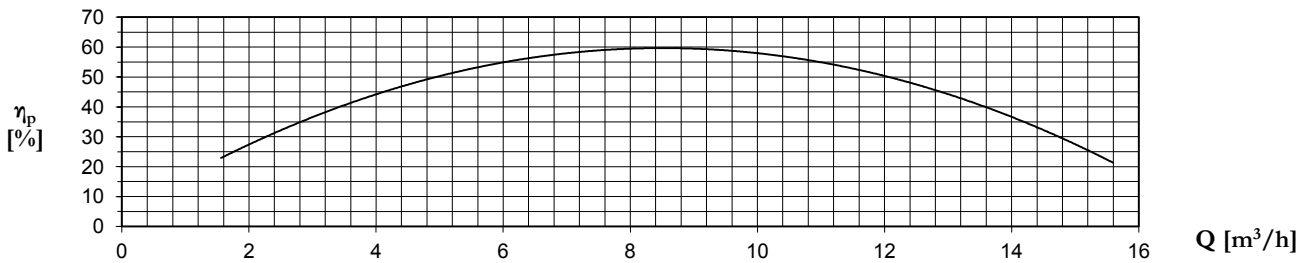
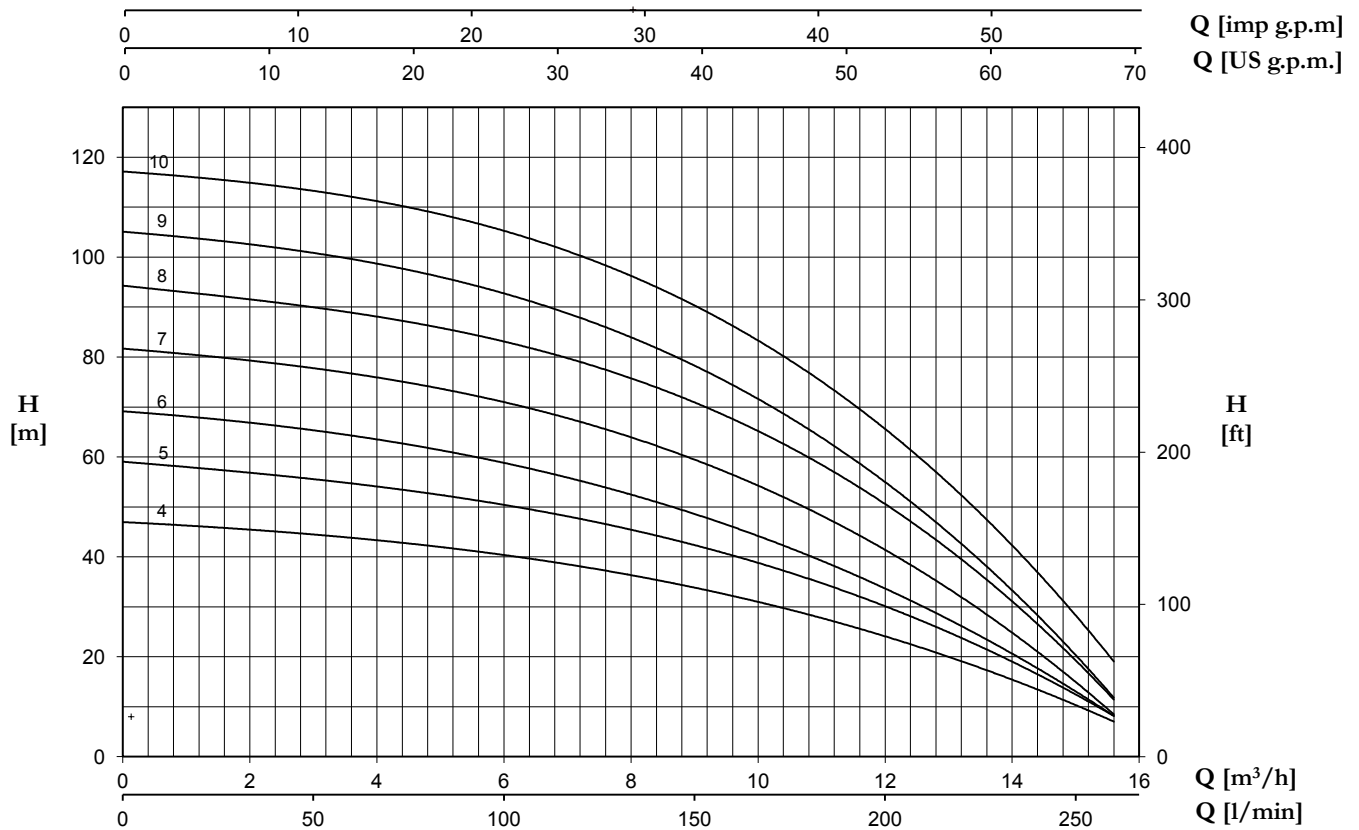

U 9... V/L		P2		P1 (kW)		AMPERE		Q (m³/h - l/min)											
1~	3~					1~	3~	0	3,6	4,8	6	7,2	8,4	9,6	10,8	12	13,2	14,4	15,6
		(HP)	(kW)	1~	3~	1x230 V 50 Hz	3x400 V 50 Hz	H (m)											
U 9...-200/4	U 9...-200/4 T	2	1,5	1,88	1,77	8,4	3,3	47,1	43,5	42,0	40,5	38,3	35,7	32,4	28,4	23,8	18,9	13,3	7,3
U 9...-250/5	U 9...-250/5 T	2,5	1,87	2,32	2,18	10,6	4,3	59,2	54,4	52,4	50,4	47,9	44,8	40,5	35,5	29,8	23,5	16,3	8,5
U 9...-300/6	U 9...-300/6 T	3	2,2	2,74	2,64	12,2	4,8	69,4	63,7	61,4	58,8	55,6	51,6	46,5	40,3	33,5	25,4	17,0	9,0
-	U 9...-400/7 T	4	3	-	3,09	-	5,7	82,0	76,0	73,7	70,9	67,5	63,0	57,0	49,7	41,0	31,2	20,1	9,5
-	U 9...-450/8 T	4,5	3,37	-	3,67	-	6,4	94,5	88,4	86,0	83	79,4	74,7	68,0	59,8	49,8	38,9	27,0	11,6
-	U 9...-500/9 T	5	3,7	-	4,03	-	6,9	105,4	98,9	96,1	92,7	88,5	82,8	75,0	65,4	54,5	41,8	28,0	12,5
-	U 9...-550/10 T	5,5	4,0	-	4,57	-	8,3	117,6	111,0	108,4	105,3	101,1	95,1	87,2	76,7	64,8	51,2	36,4	20,1

ULTRA V/L

18 V/L

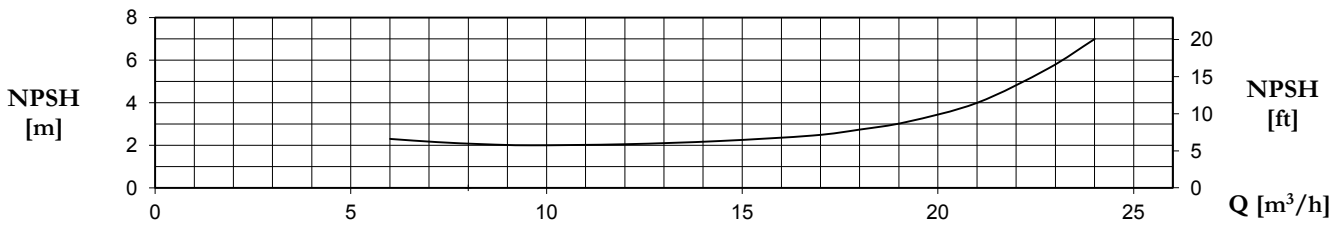
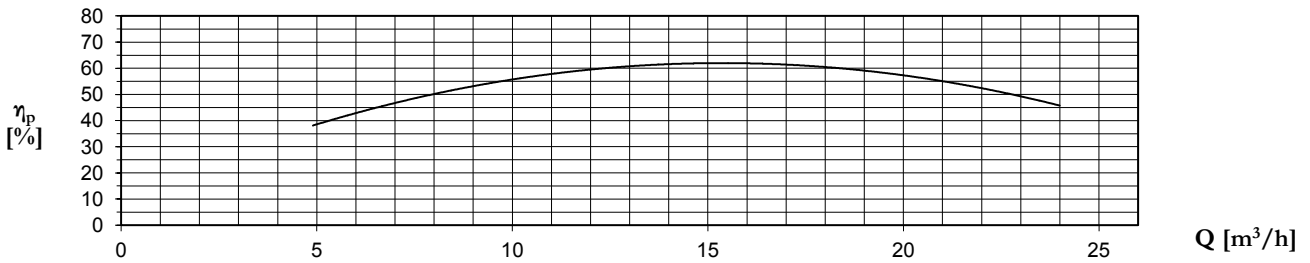
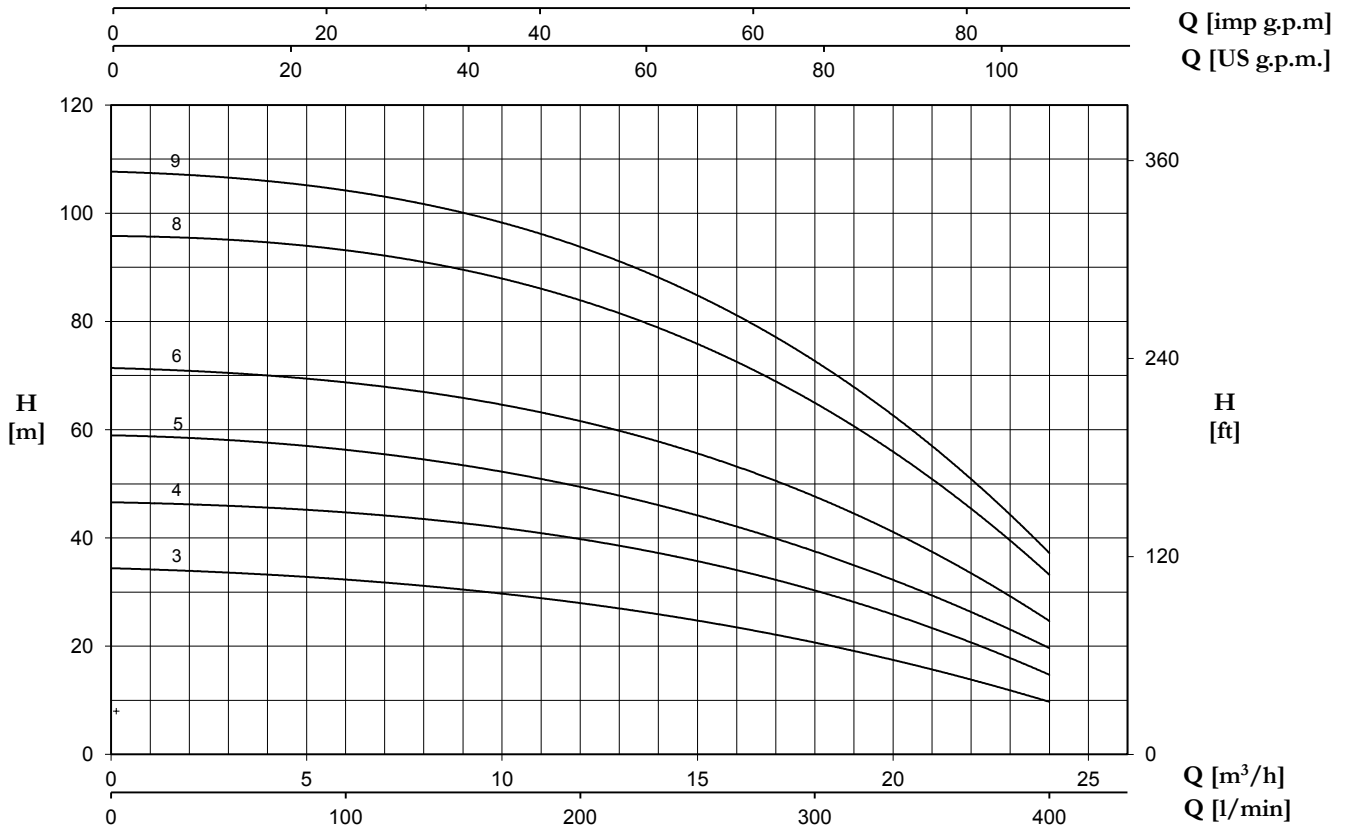

U 18... V/L	P2		P1 (kW)	A	Q (m³/h - l/min)																	
					3~	0	6	7,2	8,4	9,6	10,8	12	13,2	14,4	15,6	16,8	18	19,2	20,4	21,6	22,8	24
						0	100	120	140	160	180	200	220	240	260	280	300	320	340	360	380	400
3~	(HP)	(kW)	3~	3x400 V 50 Hz	H (m)																	
U 18...-250/3 T	2,5	1,85	2,19	4,3	34,5	32,0	31,6	30,9	30,1	29,1	28,1	26,8	25,5	24,1	22,5	20,7	18,7	16,5	14,4	12,2	10,0	
U 18...-400/4 T	4	3	2,99	5,5	46,8	44,2	43,7	43,1	42,4	41,3	40,1	38,6	36,9	35	32,6	30,1	27,4	24,5	21,5	18,4	15,2	
U 18...-450/5 T	4,5	3,31	3,68	6,6	59,1	55,9	55,1	54,1	52,8	51,3	49,7	47,7	45,5	43,0	40,3	37,3	34,3	30,9	27,4	23,9	19,8	
U 18...-550/6 T	5,5	4	4,51	8,7	71,6	68,2	67,4	66,5	65,4	63,8	61,9	59,7	57	54,2	51,1	47,6	43,7	39,5	34,7	29,9	25,2	
U 18...-750/8 T	7,5	5,5	6	10,7	96,1	92,6	91,5	90,1	88,5	86,6	84,4	81,6	78,3	74,5	69,8	64,7	59,1	53,3	46,9	40,5	34,3	
U 18...-900/9 T	9	6,6	7,17	12,8	108,0	103,6	102,3	100,8	99,0	96,9	94,1	91,1	87,5	83,0	78,3	72,6	66,2	59,6	52,6	45,5	38,3	

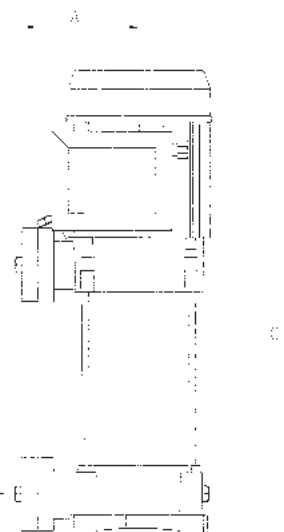
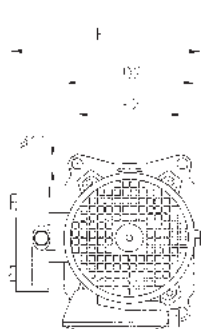
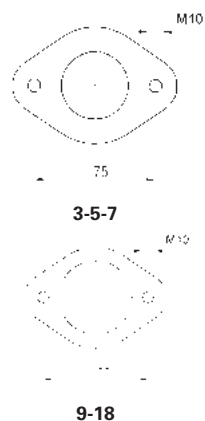

U 3V	DIMENSIONS (mm)										Kg	DNA	DNM
	A	C	D1	D2	E1	E2	F	G	H1	H2			
U 3V-100/5	135	413	204	162	178,5	125	229	213	40	178	17,7	1"1/4G	1"1/4G
U 3V-120/6	135	437	204	162	178,5	125	229	213	40	202	18,1		
U 3V-150/7	135	491	204	162	178,5	125	229	220	40	226	21		
U 3V-180/8	135	515	204	162	178,5	125	229	220	40	250	21,8		
U 3V-200/9	135	539	204	162	178,5	125	229	220	40	274	23		
U 3V-250/10	135	563	204	162	178,5	125	229	220	40	298	23,5		
U 3V-280/11	135	M 632	204	162	178,5	125	229	M 228	40	322	24,7		
		T 587						T 220					
U 3V-300/12	135	M 656	204	162	178,5	125	229	M 228	40	346	26		
		T 611						T 220					

U 5V	DIMENSIONS (mm)										Kg	DNA	DNM
	A	C	D1	D2	E1	E2	F	G	H1	H2			
U 5V-120/4	135	389	204	162	178,5	125	229	213	40	178	18,4	1"1/4G	1"1/4G
U 5V-150/5	135	443	204	162	178,5	125	229	220	40	202	20,7		
U 5V-180/6	135	467	204	162	178,5	125	229	220	40	226	21,6		
U 5V-200/7	135	491	204	162	178,5	125	229	220	40	250	23,4		
U 5V-250/8	135	515	204	162	178,5	125	229	220	40	274	24		
U 5V-280/9	135	M 584	204	162	178,5	125	229	M 228	40	298	26,3		
		T 539						T 220					
U 5V-300/10	135	M 608	204	162	178,5	125	229	M 228	40	322	26,7		
		T 563						T 220					
U 5V-350/11	135	632	204	162	178,5	125	229	228	40	346	29,7		
U 5V-380/12	135	656	204	162	178,5	125	229	228	40	370	30,4		

U 7V	DIMENSIONS (mm)										Kg	DNA	DNM
	A	C	D1	D2	E1	E2	F	G	H1	H2			
U 7V-180/4	135	419	204	162	178,5	125	229	220	40	178	21	1"1/4G	1"1/4G
U 7V-250/5	135	443	204	162	178,5	125	229	220	40	202	23		
U 7V-300/6	135	M 512	204	162	178,5	125	229	M 228	40	226	25,5		
		T 467						T 220					
U 7V-350/7	135	536	204	162	178,5	125	229	228	40	250	25,9		
U 7V-400/8	135	560	204	162	178,5	125	229	228	40	274	28,8		
U 7V-450/9	135	617	204	162	178,5	125	235	243	40	301	33,3		
U 7V-550/10	135	641	204	162	178,5	125	235	243	40	325	36,3		

U 9V	DIMENSIONS (mm)										Kg	DNA	DNM
	A	C	D1	D2	E1	E2	F	G	H1	H2			
U 9V-200/4	135	443	204	162	178,5	125	229	220	40	202	22,6	1"1/2G	1"1/4G
U 9V-250/5	135	473	204	162	178,5	125	229	220	40	232	23,2		
U 9V-300/6	135	M 548	204	162	178,5	125	229	M 228	40	262	25,9		
		T 503						T 220					
U 9V-400/7	135	578	204	162	178,5	125	229	228	40	292	28,8		
U 9V-450/8	135	641	204	162	178,5	125	235	243	40	325	33,2		
U 9V-500/9	135	671	204	162	178,5	125	235	243	40	355	33,7		
U 9V-550/10	135	701	204	162	178,5	125	235	243	40	385	36,7		

U 18V	DIMENSIONS (mm)										Kg	DNA	DNM
	A	C	D1	D2	E1	E2	F	G	H1	H2			
U 18V-250/3 T	135	451	204	162	178,5	125	229	220	50	211	27,2	2" G	1"1/2G
U 18V-400/4 T	135	534	204	162	178,5	125	229	228	50	248	29,2		
U 18V-450/5 T	135	605	204	162	178,5	125	235	243	50	289	33,9		
U 18V-550/6 T	135	642	204	162	178,5	125	235	243	50	326	37,1		
U 18V-750/8 T	135	763	204	162	178,5	125	255	253	50	401	46,6		
U 18V-900/9 T	135	801	204	162	178,5	125	255	253	50	439	51,6		

ULTRA L

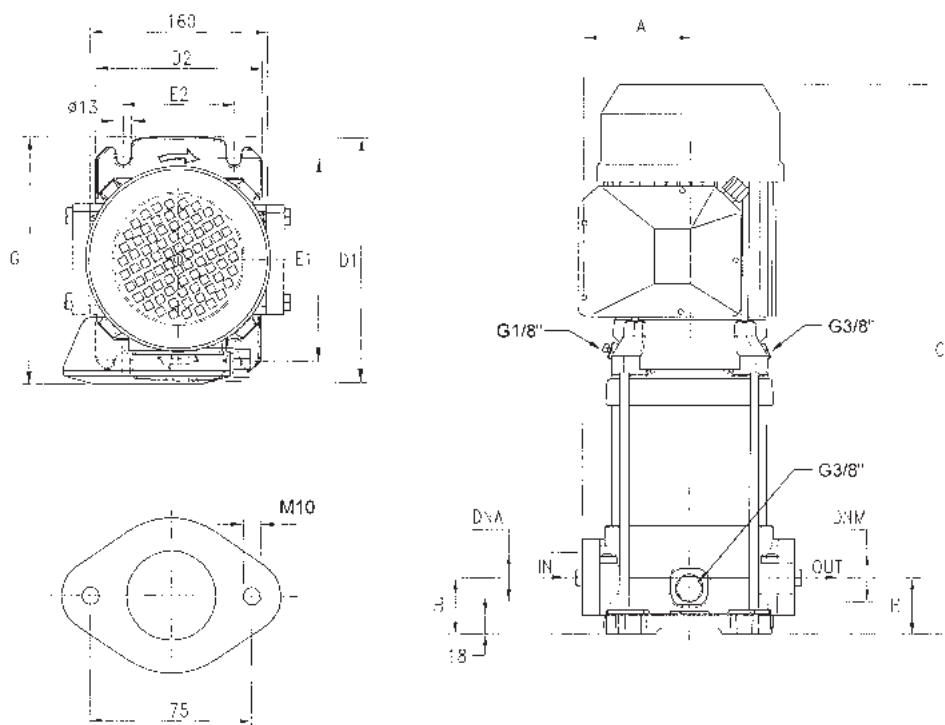

U 3L	DIMENSIONS (mm)								Kg	DNA	DNM
	A	C	D1	D2	E1	E2	G	H			
U 3L-100/5	98	429	220	150	180	100	228	50	19	1"1/4G	1"1/4G
U 3L-120/6	98	453	220	150	180	100	228	50	19,3		
U 3L-150/7	98	507	220	150	180	100	228	50	22,6		
U 3L-180/8	98	531	220	150	180	100	228	50	23,6		
U 3L-200/9	98	555	220	150	180	100	228	50	25,5		
U 3L-250/10	98	579	220	150	180	100	228	50	26,1		
U 3L-280/11	98	M 648	220	150	180	100	M 236	50	27,3	1"1/4G	1"1/4G
		T 603					T 228				
U 3L-300/12	98	M 672	220	150	180	100	M 236	50	28,4		
		T 627					T 228				

U 5L	DIMENSIONS (mm)								Kg	DNA	DNM
	A	C	D1	D2	E1	E2	G	H			
U 5L-120/4	98	405	220	150	180	100	221	50	19,4	1"1/4G	1"1/4G
U 5L-150/5	98	459	220	150	180	100	228	50	22,4		
U 5L-180/6	98	483	220	150	180	100	228	50	23,3		
U 5L-200/7	98	507	220	150	180	100	228	50	25,1		
U 5L-250/8	98	531	220	150	180	100	228	50	25,7		
U 5L-280/9	98	M 600	220	150	180	100	M 236	50	28,2		
		T 555					T 228				
U 5L-300/10	98	M 624	220	150	180	100	M 236	50	28,6		
		T 579					T 228				
U 5L-350/11	98	648	220	150	180	100	236	50	31,6		
U 5L-380/12	98	672	220	150	180	100	236	50	32,3		

U 7L	DIMENSIONS (mm)								Kg	DNA	DNM
	A	C	D1	D2	E1	E2	G	H			
U 7L-180/4	98	435	220	150	180	100	228	50	22,7	1"1/4G	1"1/4G
U 7L-250/5	98	459	220	150	180	100	228	50	24,7		
U 7L-300/6	98	M 528	220	150	180	100	M 236	50	27,3		
		T 483					T 228				
U 7L-350/7	98	552	220	150	180	100	236	50	27,7		
U 7L-400/8	98	576	220	150	180	100	236	50	30,6		
U 7L-450/9	98	633	220	150	180	100	251	50	34,9		
U 7L-550/10	98	657	220	150	180	100	251	50	38		

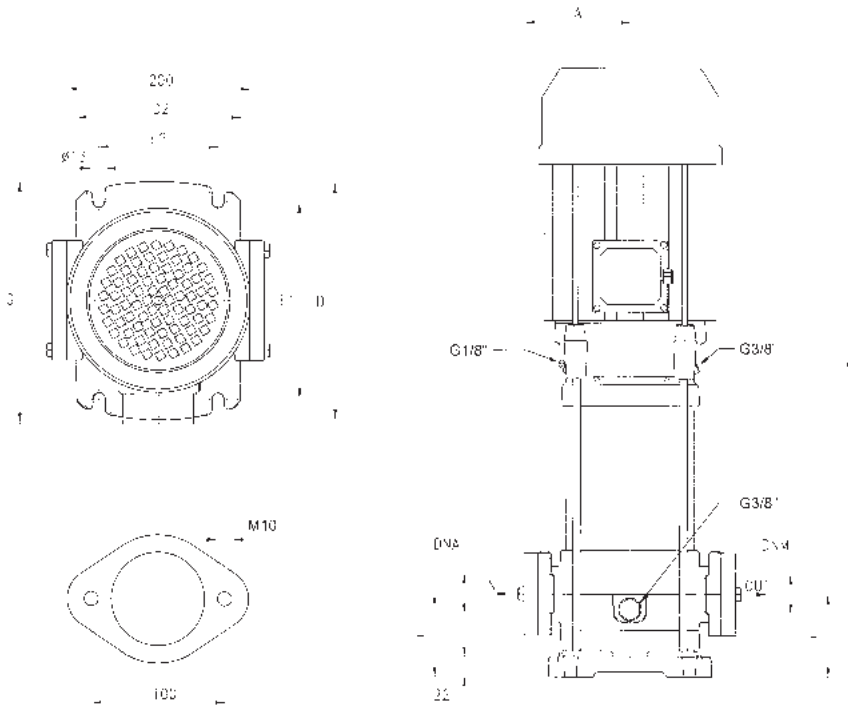

U 9L	DIMENSIONS (mm)									Kg	DNA	DNM
	A	C	D1	D2	E1	E2	G	H				
U 9L-200/4	118	490	260	180	215	130	248	80	28,6	1"1/2G	1"1/2G	
U 9L-250/5	118	520	260	180	215	130	248	80	29,2			
U 9L-300/6	118	M 595 T 550	260	180	215	130	M 256 T 248	80	31,8			
U 9L-400/7	118	625	260	180	215	130	256	80	35			
U 9L-450/8	118	688	260	180	215	130	271	80	38,6			
U 9L-500/9	118	718	260	180	215	130	271	80	39,1			
U 9L-550/10	118	748	260	180	215	130	271	80	42,1			

U 18L	DIMENSIONS (mm)									Kg	DNA	DNM
	A	C	D1	D2	E1	E2	G	H				
U 18L-250/3 T	118	452	260	180	215	130	251	90	32,1	2"G	2"G	
U 18L-400/4 T	118	575	260	180	215	130	257	90	34,2			
U 18L-450/5 T	118	646	260	180	215	130	271	90	38,1			
U 18L-550/6 T	118	683	260	180	215	130	271	90	41,5			
U 18L-750/8 T	118	804	260	180	215	130	280	90	50,4			
U 18L-900/9 T	118	842	260	180	215	130	280	90	55,3			

TYPE	TRUCK		CONTAINER	
	PALLET (cm)	N° pumps	PALLET (cm)	N° pumps
U 3V-100/5-200/9	80X120X150	42	80X120X175	49
U 3V-250/10-300/12 M	80X120X155	30	80X120X180	35
U 3V-300/12 T	80X120X150	42	80X120X175	49
U 5V-120/4-250/8	80X120X150	42	80X120X175	49
U 5V-280/9 T-300/10 T	80X120X150	42	80X120X175	49
U 5V-280/9 M-300/10 M	80X120X155	30	80X120X180	35
U 5V-350/11-380/12 T	80X120X155	30	80X120X180	35
U 7V-180/4-350/7 T	80X120X15	42	80X120X175	49
U 7V-400/8 T	80X120X155	30	80X120X180	35
U 7V-450/9 T-550/10 T	85X110X125	20	85X110X150	24
U 9V-200/4	80X120X150	42	80X120X175	49
U 9V-250/5-300/6 T	80X120X150	42	80X120X175	49
U 9V-300/6 M-400/7 T	80X120X155	30	80X120X180	35
U 9V-450/8 T-550/10 T	85X110X125	20	85X110X150	24
U 18V-250/3 T-400/4 T	80X120X150	42	80X120X175	49
U 18V-450/5 T-550/6 T	85X110X125	20	85X110X150	24
U 18V-750/8 T-900/9 T	100X120X150	12	100X120X150	12

TYPE	TRUCK		CONTAINER	
	PALLET (cm)	N° pumps	PALLET (cm)	N° pumps
U 3L-100/5-180/8	85X110X150	36	85X110X170	42
U 3L-200/9-300/12	80X120X150	30	80X120X170	35
U 5L-120/4-250/8	85X110X150	36	85X110X170	42
U 5L-280/9-380/12 T	80X120X150	30	80X120X170	35
U 7L-180/4-300/6 T	85X110X150	36	85X110X170	42
U 7L-300/6 M-400/8 T	80X120X150	30	80X120X170	35
U 7L-450/9 T-550/10 T	80X120X150	30	80X120X170	35
U 9L-200/4-400/7 T	80X120X155	25	80X120X185	30
U 9L-450/8 T-550/10 T	85X110X150	20	85X110X150	20
U 18L-250/3 T-400/4 T	80X120X155	25	80X120X185	30
U 18L-450/5 T-550/6 T	85X110X150	20	85X110X150	20
U 18L-750/8 T-900/6 T	85X110X150	20	85X110X150	20